

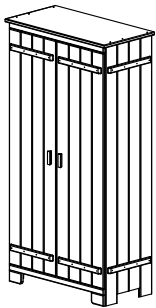

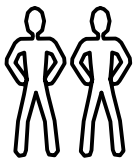









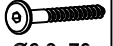



Art.Nr: 6001 (200 X 103 X 53)



WK		x 4	LR		x 1	AE		Ø8x30	x 15
FK		x 4	LV		x 6	OC		Ø7x50	x 6
NV		x 6	DR		x 4	NI			x 16
AS		x 50	NK		x 4	MI		Ø15H 12	x 10
RS		x 2	CB		x 28	MB		H34	x 10
						SD			x 6

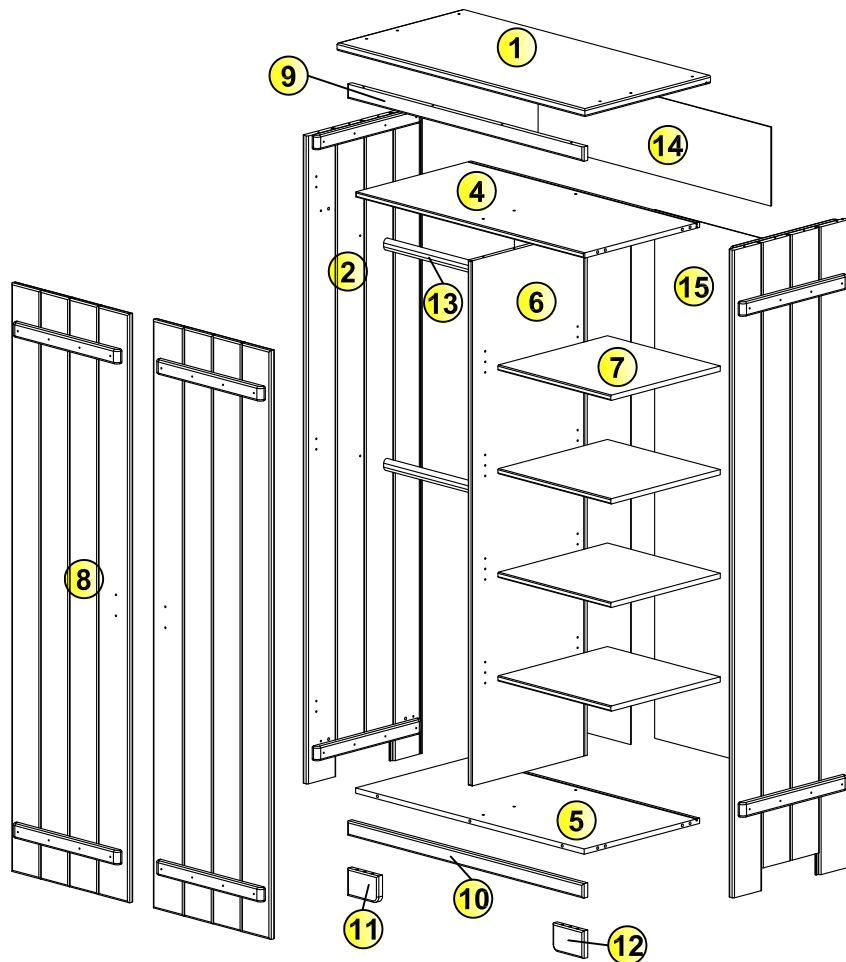

Teile nr.	Anzahl	Maß(mm)
1	1	1014x522x24
2	1	1960x480x20
3	1	1960x480x20
4	1	934x480x16
5	1	934x480x16
6	1	1602x480x16
7	4	457x455x16
8	2	1796x480x20
9	1	964x44x20
10	1	964x44x20
11	1	127x84x20
12	1	127x84x20
13	2	449x36x24
14	1	952x247x3
15	2	1626x476x3

Dear customer.

Here You have possibility of measuring the supplied screws.

Geehrter Kunde.

Hier haben Sie die Möglichkeit die mitgelieferten Schrauben nachzumessen.

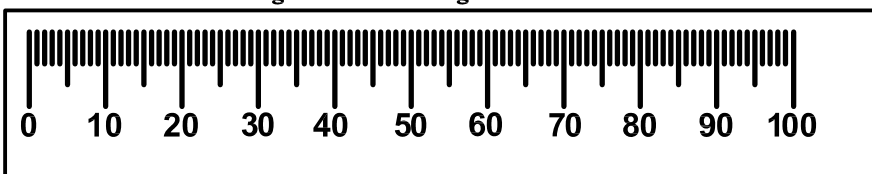

1

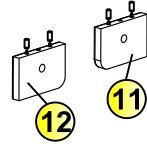
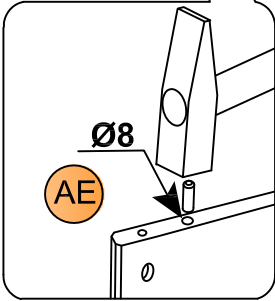
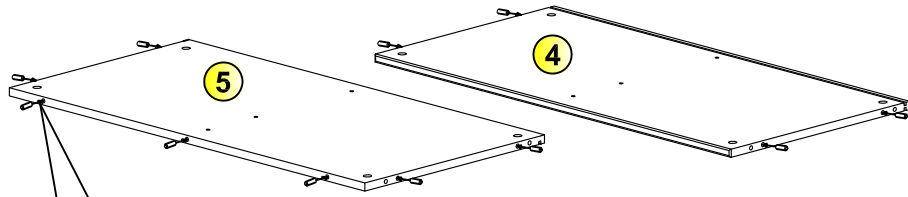

2

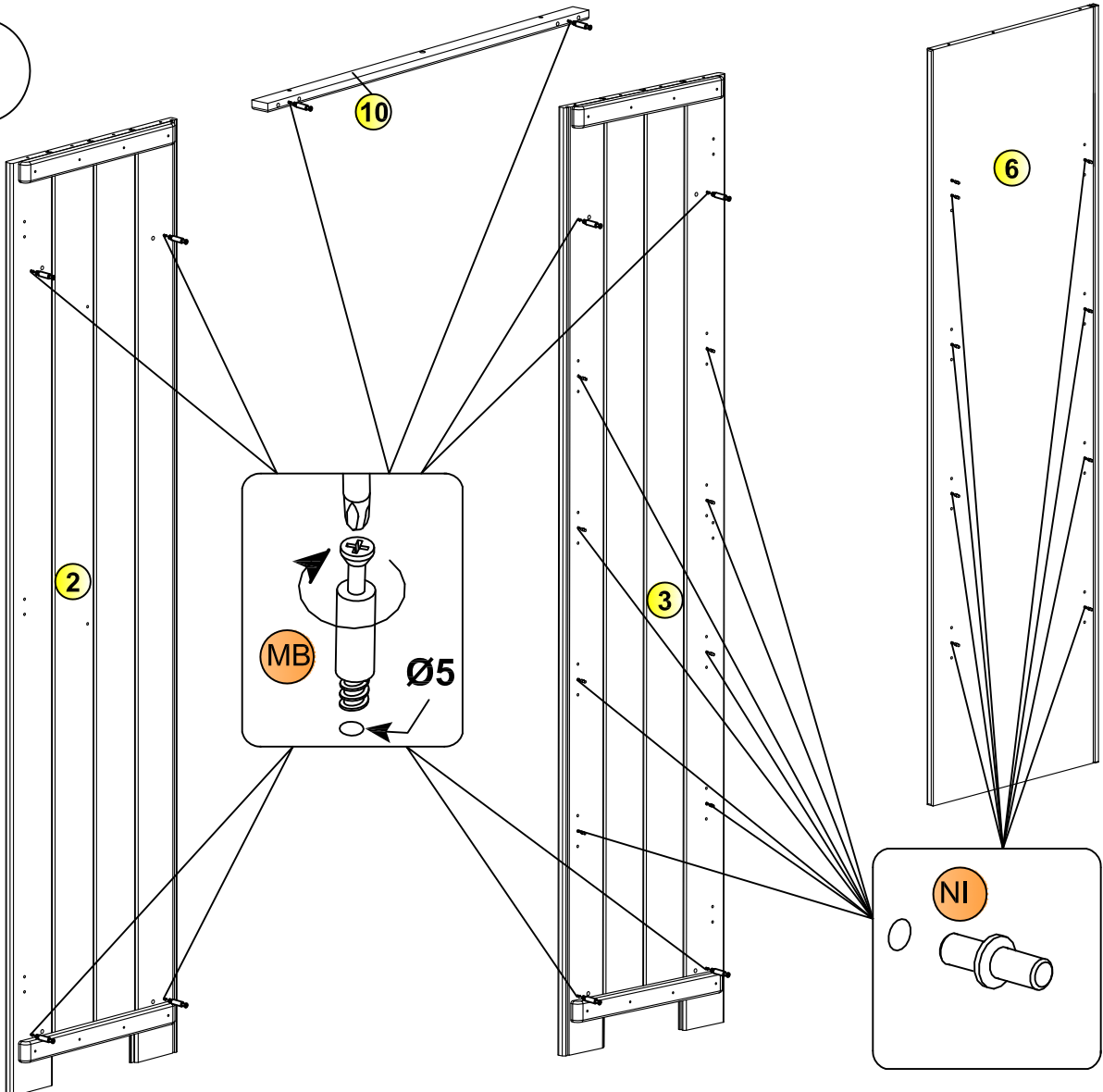

3

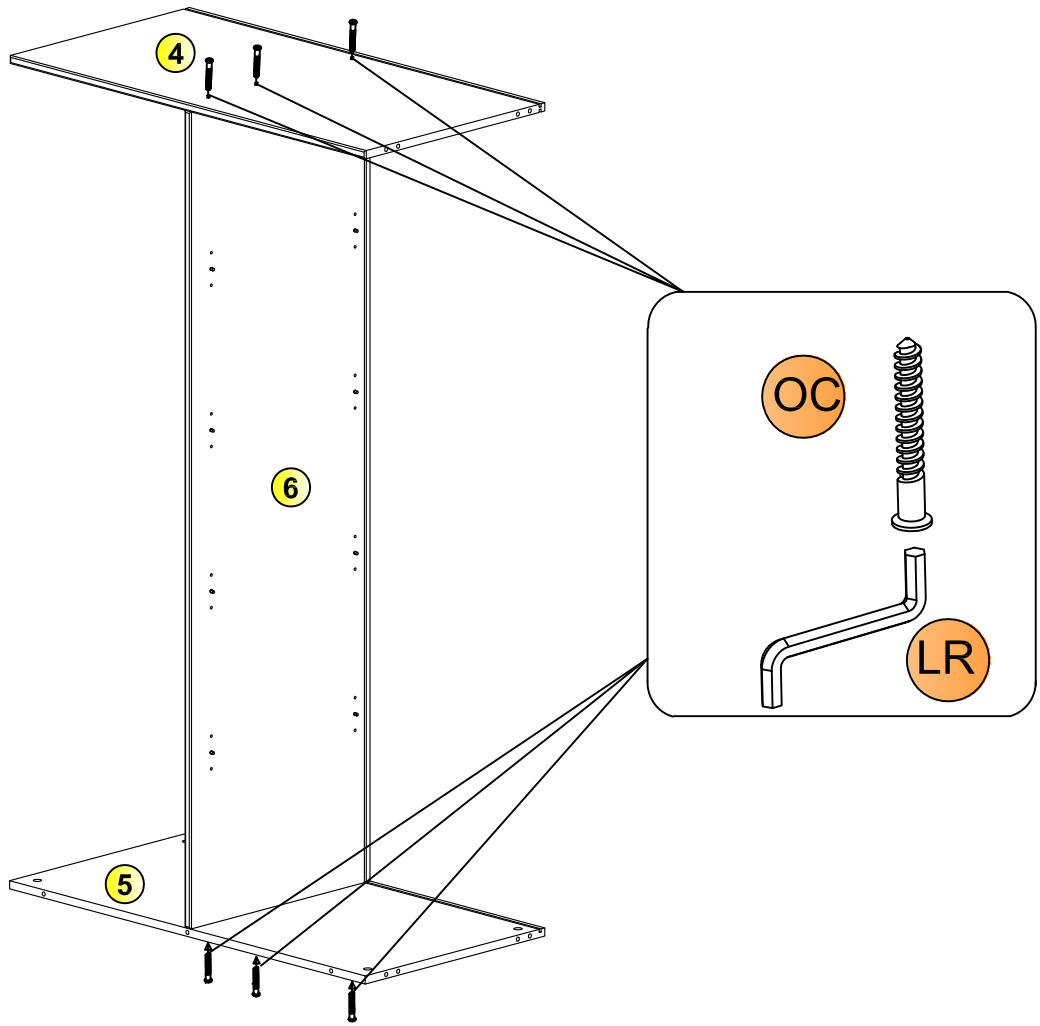

4

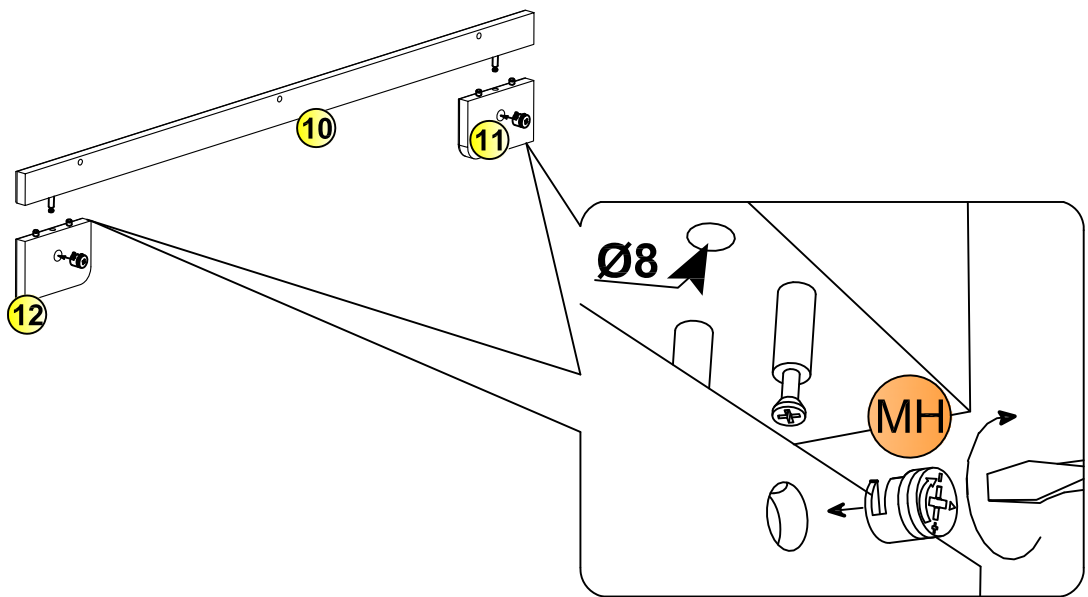

5

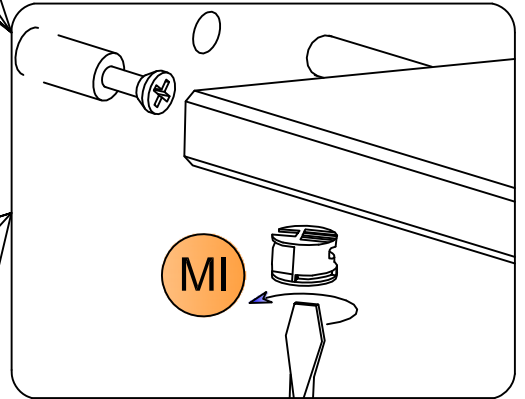
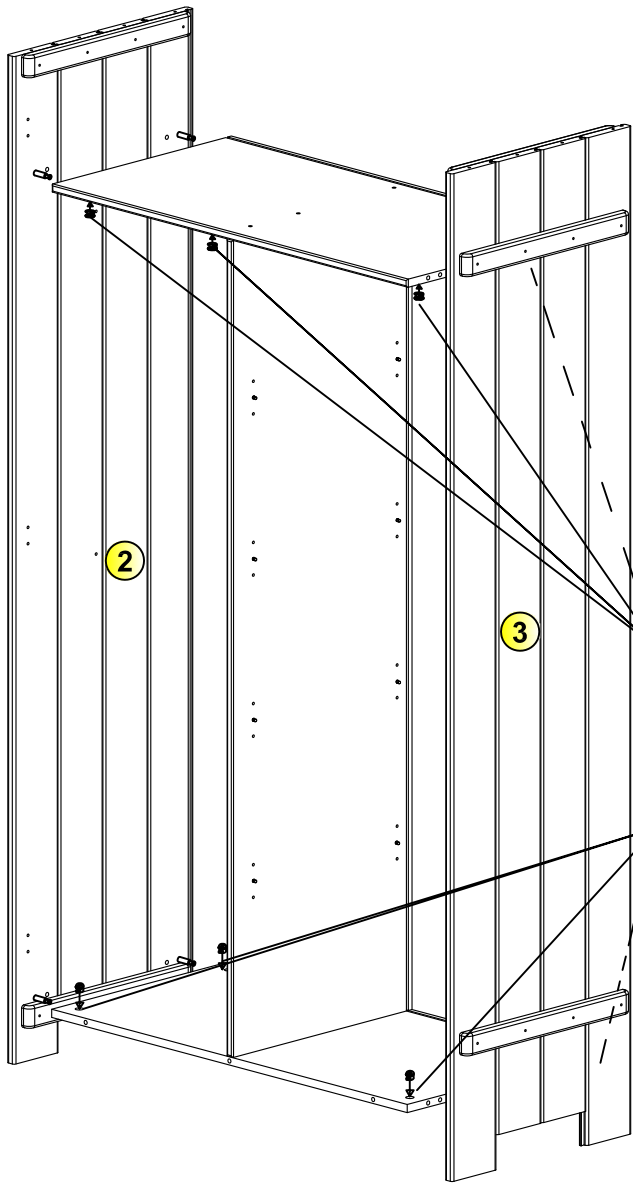

6

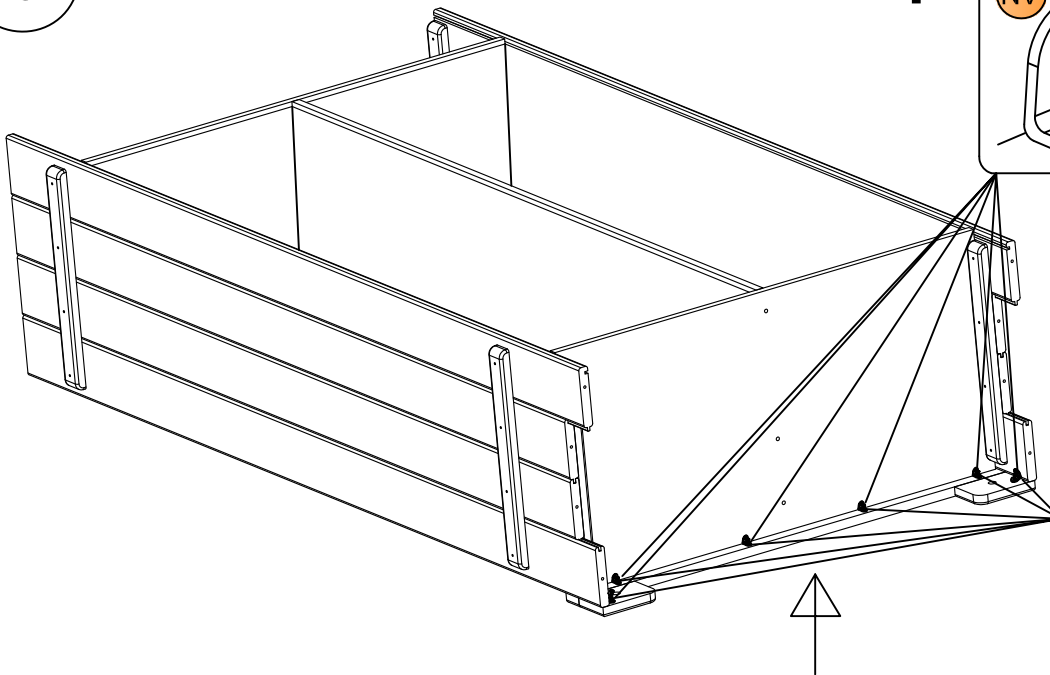

1

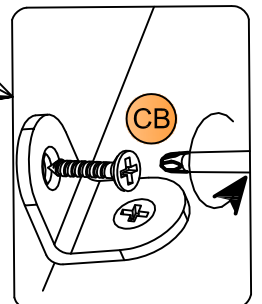
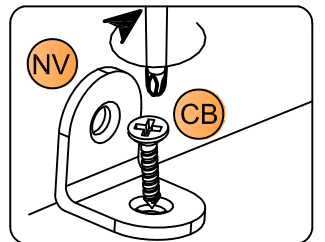

7

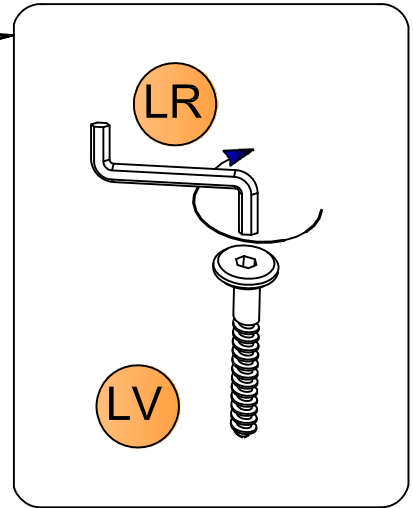
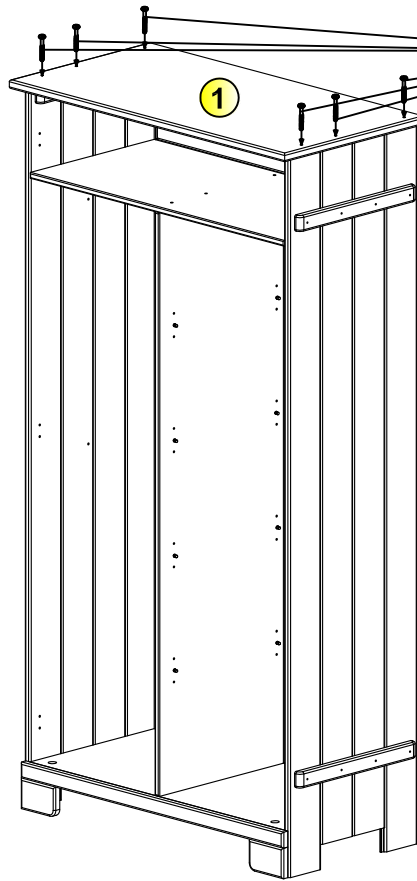

8

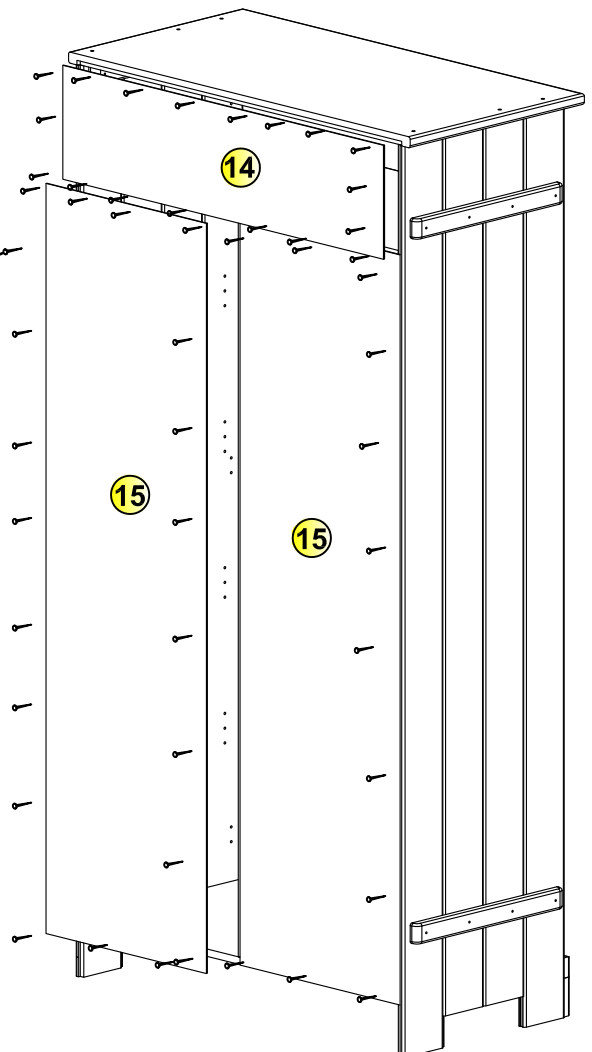
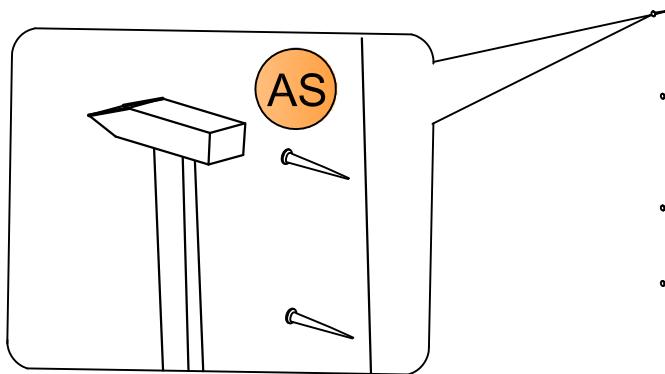

9

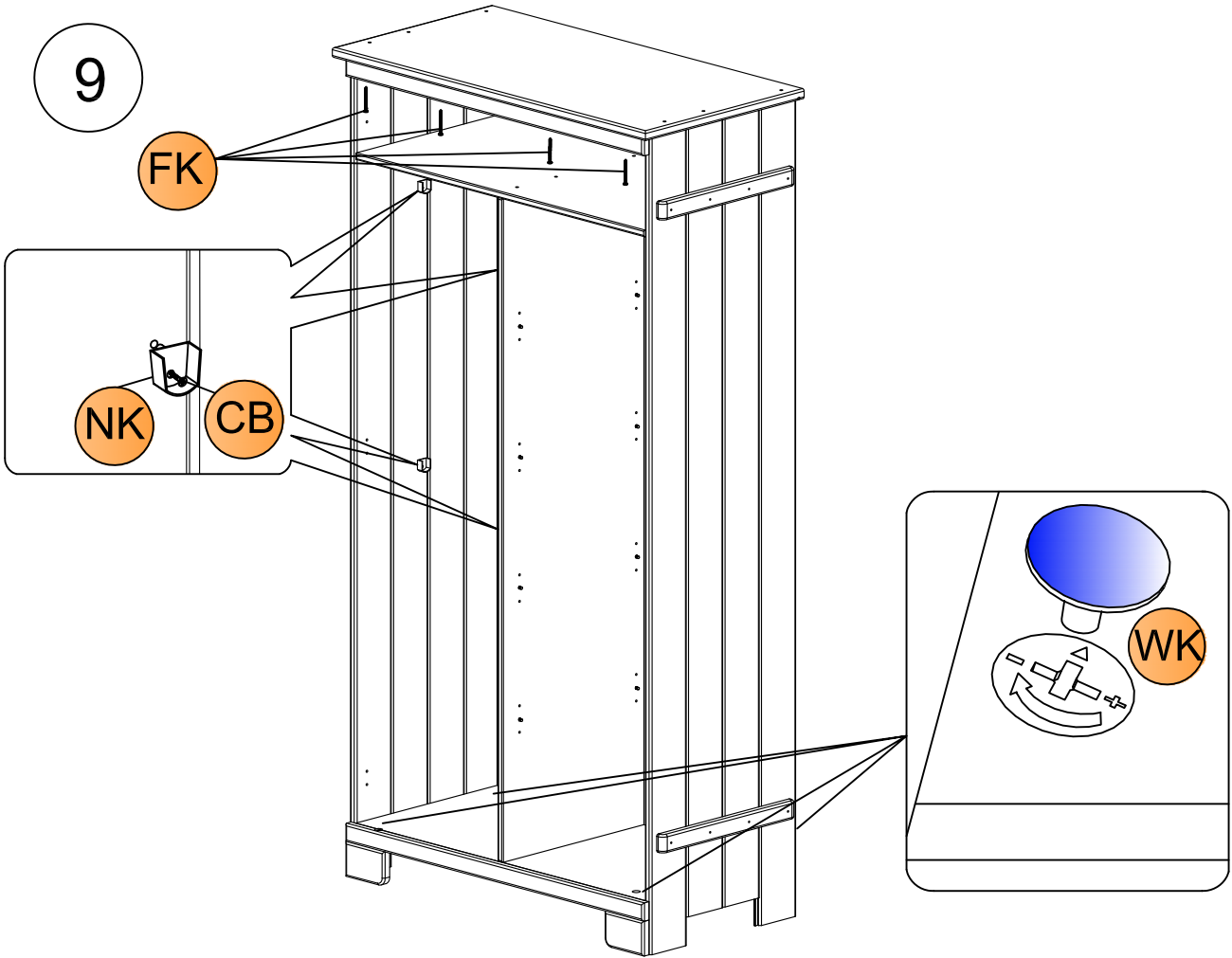

10

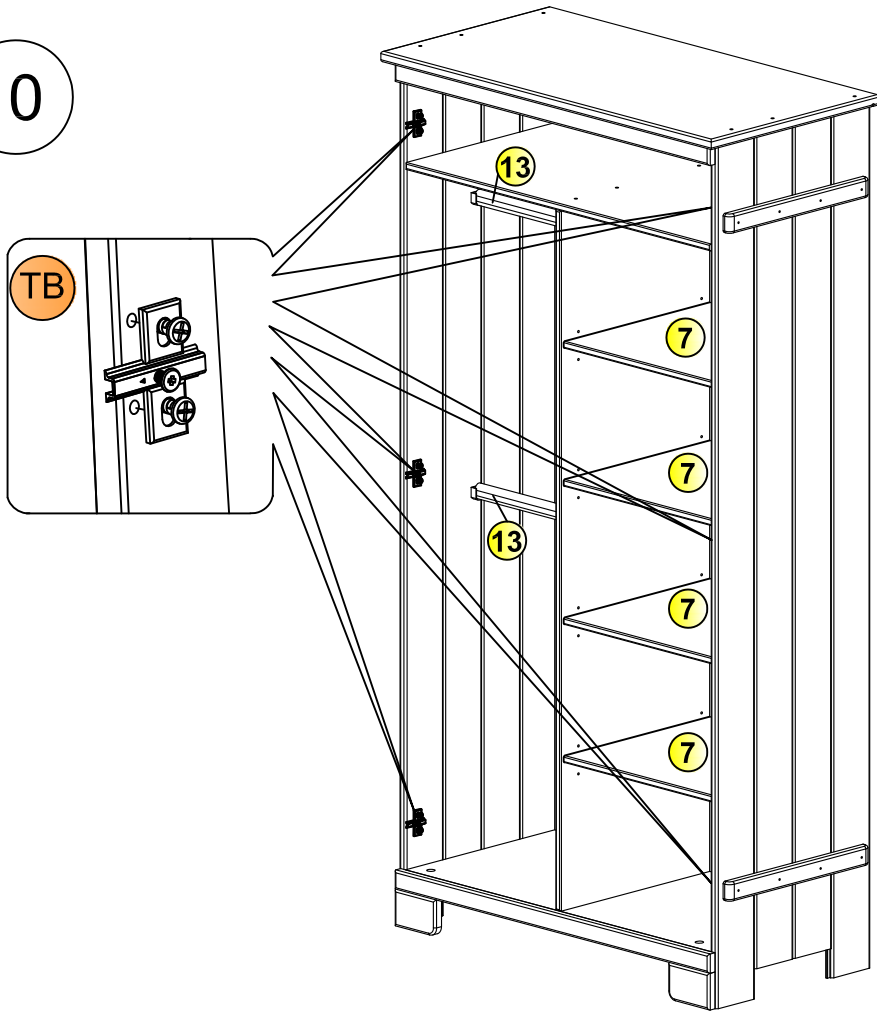

11

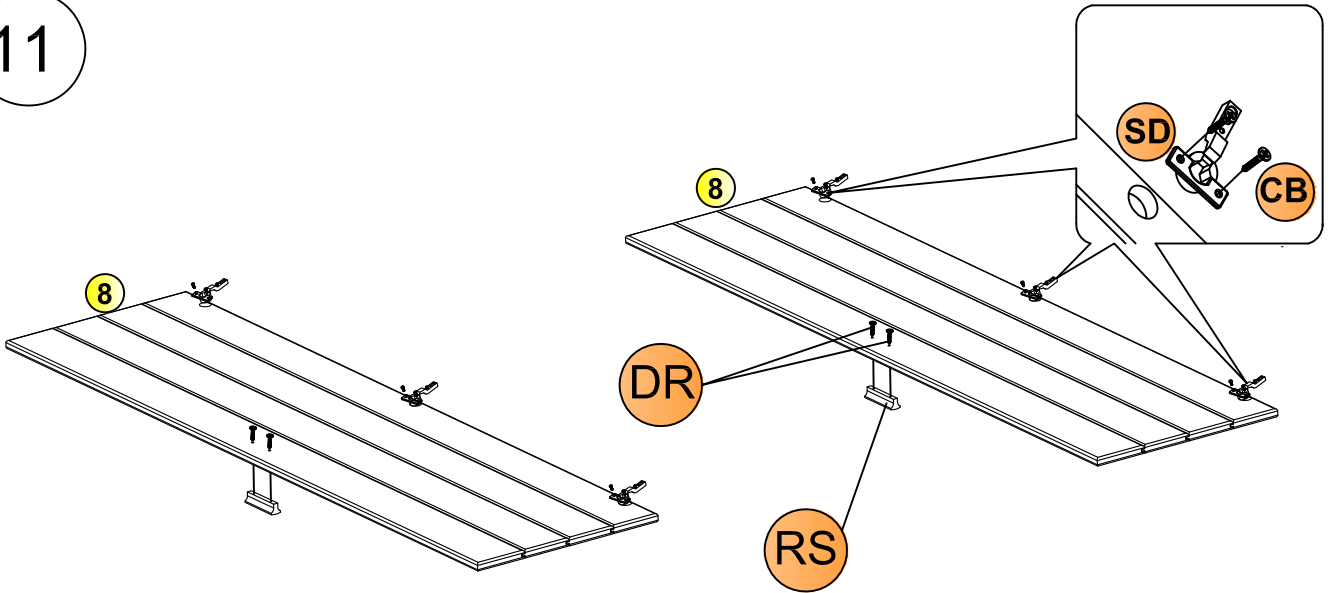

12

